

# Product Data Sheet

---

---

## COB LED STRIP RGB SERIES

2019.12-V01



## Description

The FOB white series strip are created with high intensity LED chips mounted on a flexible printed circuit board (FPCB) with a strong 3M adhesive backing. It's new COB lighting design so the light is soft and without any light dot. The flexible design of LED strips allows for the addition of beautiful and pure white light in almost any space you can imagine. The EVERLUSTER'S LED strips are a great way to provide professional grade, bright and comfortable accent lighting that will last for many years.

## Product Features

- COB design, without any light dot
- 180° light big view angle
- Much small size bendable
- Flexible lighting design
- Long life time

## Application

- Home furnishing lighting
- Commercial lighting
- Linear lighting
- Office lighting, shopping center
- Any simplicity lighting design

## Photos



## Electrical And Optical Characteristics

Product SKU	Chipsites	Color	Voltage	Watt/foot (Meter)	Lumen/foot (Meter)
VT-FOB-630-24VDW-E10	630	RGB	24V	18W/m 5.49W/ft	/
*Based on after mixed natural white					

\*CRI>80 and CRI>90 can be choice.

\*CCT may be +/-100K but always ordered from same bin and will present no noticeable differences perceived by the human eye.

Customized special color or CRI is acceptable

## Absolute Max. Value

Parameters	Symbol	Max.	Unite
Forward Current	IF	1000	mA
Power	PD	24	W
Antistatic	ESD	2000	V
Work Temperature	WT	-25-40	°C
Storage Temperature	ST	-40-60	°C

## (X ,Y ) Chromaticity Diagram

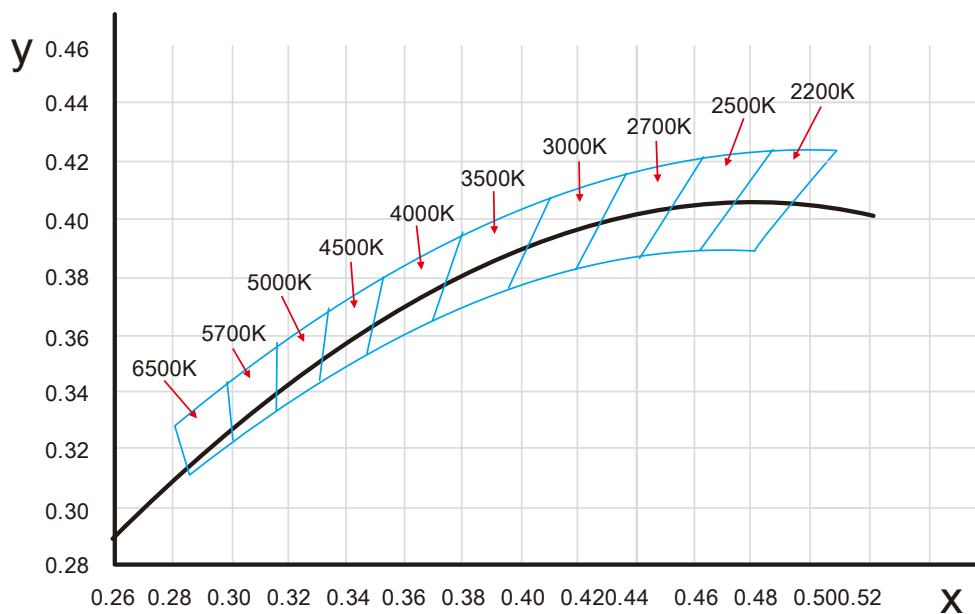

## Reliability Experiment

### Optical Testing

Spectrum Analysis	IES LM 79 (Lumen, CCT, CRI, XY, SDCM, wavelength)
Photometric Distribution	IES LM 73 (Lumen intensity distribution & Lux diagram)
Lumen Maintenance & Lifetime	IES LM 84 & IES TM28

### Durability Testing

Bending Test	Manufacturer-defined, 500 cycles
Swing Test	UL2388, >750 cycles
Tensile Test	Manufacturer-defined, > the weight of light in max. connection length double feed
Swing Test	Max connection length double feed Manufacturer-defined, >200 cycles
Ball Impact	IEC60598-1 & IEC60598-2-21

### Environmental Testing

Salt Water Immersion	IEC60598-1, Salinity 4%
Swing Test	UL2388, >750 cycles
Outdoor Exposure	Manufacturer-defined
Flame Resistance	UL94
UV Exposure	ASTMG 154, ISO 4892-3, UVA @ 340nm
IPX5, IPX6, IPX7, IPX8	IEC60529
Temperature Shock	Manufacturer-defined, -40°C - 60°C (typical temperature)

# DIMENSIONS

24V

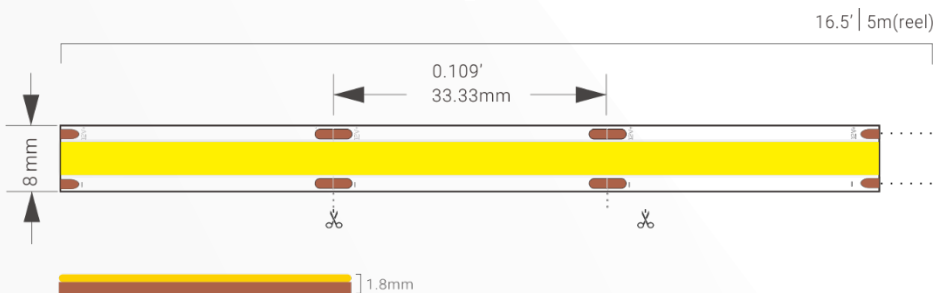

## Minimum Bend Diameter

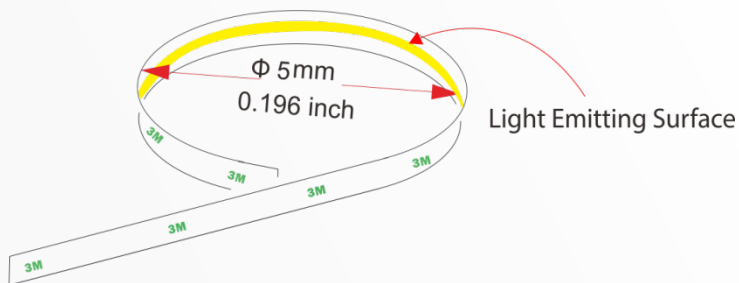

## Order Guide

Brand	Strip Type	Chip Qty	Voltage	CCT/Color
VT	—			
	FOB	576	24V	WW=2700-3300K
	F=Flexible strip	504	12V	NW=4000-4500K
	N=Neon strip	420		CW=6000-6500K
		378		DW=2700-6500K
		....		

\* All Technical information in this document is subject to change. Copyright © EVERLUSTER.

## Installation Guide

AC outlet  
(OR AC source)

In Series

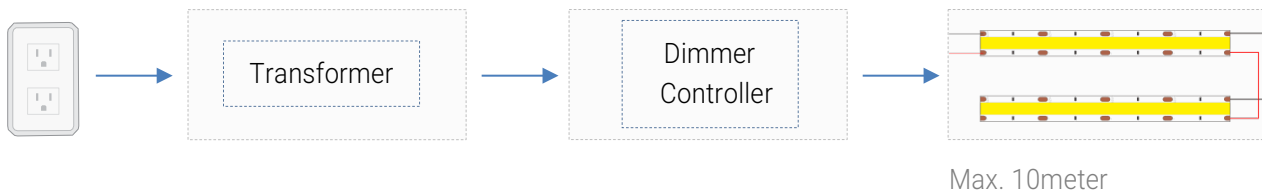

AC outlet  
(OR AC source)

In Parallel

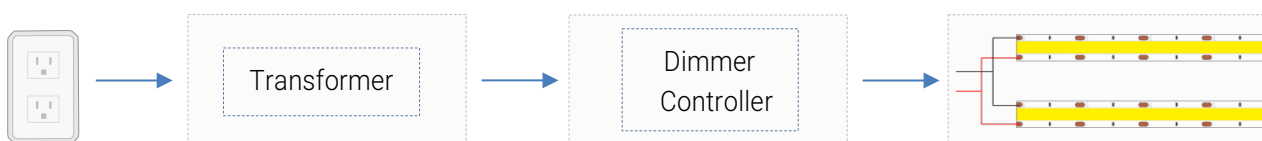

## Solderless Connection Guide

1. Cut the strip

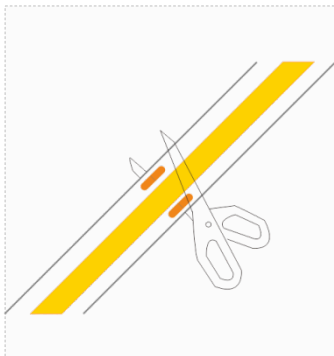

2. Rip a little 3M tape

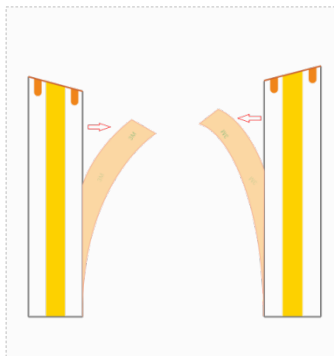

3. Insert the strips

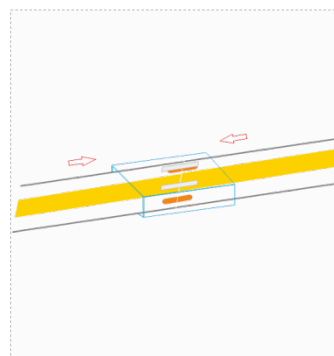

4. Press contact terminal

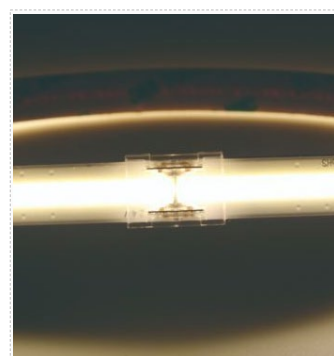
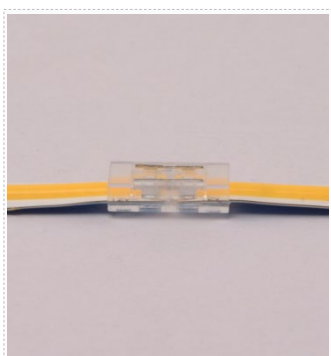
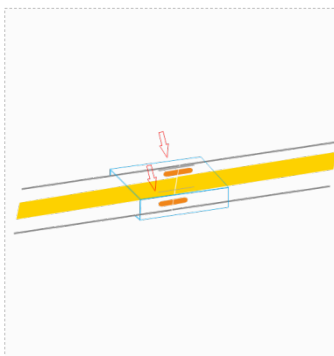

## Package

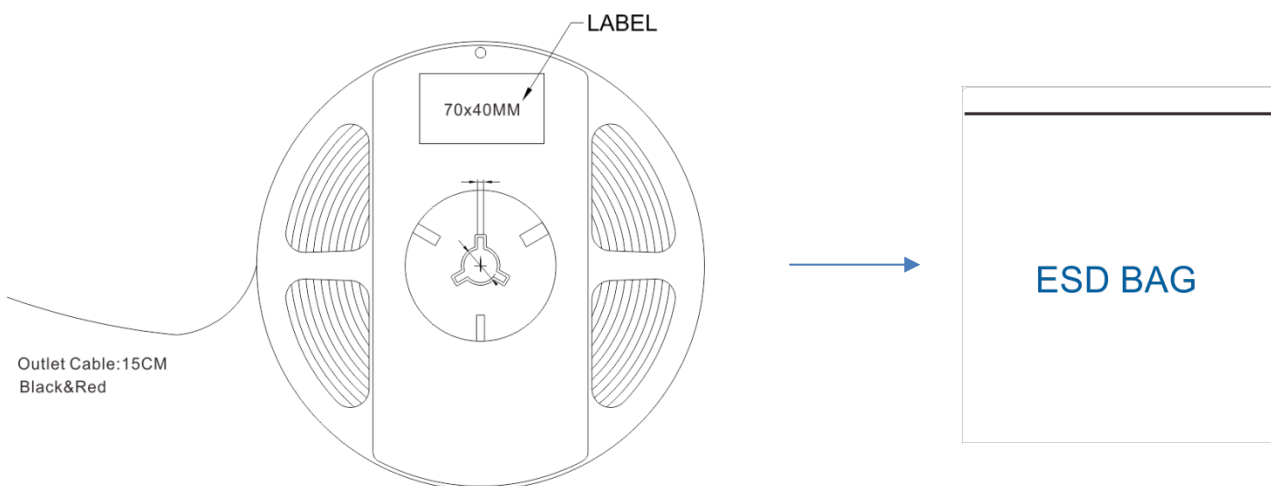



## Safety And Disclosures

---

1. Installation must be in accordance with local and national electrical code regulations.
2. To ensure safety and correct installation, our strips are intended to be installed by a qualified, licensed electrician.
3. LED strip lights must be handled with care. Excessive handling, bending, and pressure may damage the product, voiding the warranty.
4. Do not install indoor LED tape light products in outdoor / wet location environments. Only use copper wiring. Use wires rated for at least
5. Each maximum run requires a dedicated power feed from the driver. Do not extend beyond the recommended maximum run length.
6. Do not modify product beyond instructions or warranty will be void.

## Warranty Information

---

### Consumer's Acknowledgment

When you purchase our products, you are agreeing to the terms and conditions outlined in our warranty section. We try our best to make recommendations, but the burden of proper installation, design, and maintenance relies on the purchaser.

### Limited Warranty

This product has a 5 year limited warranty from the date of shipment. This warranty only includes the main product outlined in this specification sheet and does not include the additional accessories that are used as a reference. For warranty related questions please contact product support team at (sale@everluster.com).